



Timer modules

86
SERIES



Machines for ceramics



Machines for paper processing



Printing machines



Packaging machines



Wood-processing machines



Milk processing plant



Textile machines

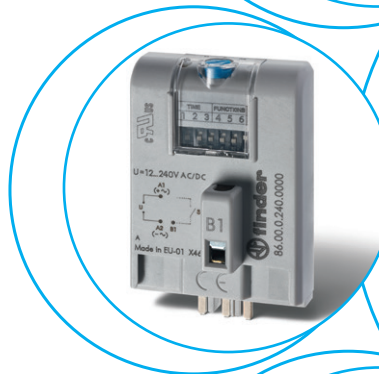

Timer modules for use in conjunction with relay & socket.

86.00 - Multi-function & multi-voltage timer module

86.30 - Bi-function & multi-voltage timer module

- Timer module type 86.00 for 90, 92, 96 series sockets and type 86.30 for 90, 92, 94, 95, 96, 97 series sockets
- Wide supply voltage range:
12...240 V AC/DC (86.00)
12...24 V AC/DC or 230...240 V AC (86.30)
- LED indicator
- Atex versions available

86.00



- Time scale: from 0.05 s to 100 h
- Multi-function
- Plug-in for use with 90.02, 90.03, 92.03 and 96.04 sockets

86.30



- Time scale: from 0.05 s to 100 h
- Bi-function
- Plug-in for use with 90.02, 90.03, 92.03, 94.P3, 94.P4, 94.02, 94.03, 94.04, 95.P3, 95.P5, 95.03, 95.05, 96.02, 96.04, 97.P1, 97.P2, 97.01 and 97.02 sockets

- AI:** On-delay
DI: Interval
SW: Symmetrical flasher (starting pulse on)
BE: Off-delay with control signal
CE: On- and off-delay with control signal
DE: Interval with control signal on
EE: Interval with control signal off
FE: Interval with control signal on and off

- AI:** On-delay
DI: Interval

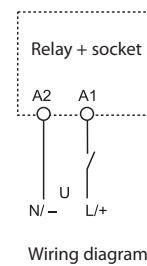
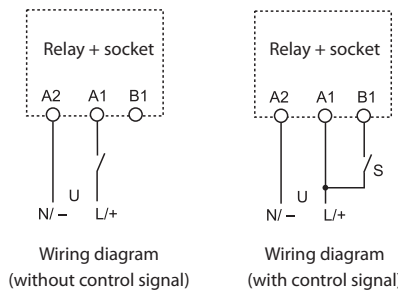

* For Atex versions, refer to the "Other data" table on the page 2
 For outline drawing see page 3

Contact specification*

Contact configuration	
Rated current/Maximum peak current	A
Rated voltage/Maximum switching voltage	V AC
Rated load AC1	VA
Rated load AC15 (230 V AC)	VA
Single phase motor rating (230 V AC)	kW
Breaking capacity DC1: 30/110/220 V	A
Minimum switching load	mW (V/mA)
Standard contact material	

See 56, 60 and 62 series relays
 Note: Do not use with relays 62.3x.x012.x300 and 62.3x.x012.x600

See 40, 44, 46, 55, 56, 60 and 62 series relays

Supply specification*

Nominal voltage (U _N)	V AC (50/60 Hz)
	V DC
Rated power AC/DC	W
Operating range	V AC (50/60 Hz)
	DC

12...240	12...24	110...125	230...240
12...240	12...24	—	—
1.2	0.15		
10.2...265	9.6...33.6	88...137	184...265
10.2...265	9.6...33.6	—	—

Technical data

Specified time range	(0.05...1)s, (0.5...10)s, (5...100)s, (0.5...10)min, (5...100)min, (0.5...10)h, (5...100)h		
Repeatability	%	± 1	± 1
Recovery time	ms	≤ 50	≤ 50
Minimum control impulse	ms	50	—
Setting accuracy full range	%	± 5	± 5
Electrical life at rated load in AC1	cycles	See 56, 60 and 62 series relays	See 40, 44, 46, 55, 56, 60 and 62 series relays
Ambient temperature range	°C	-20...+50	-20...+50
Protection category		IP 20	IP 20

Approvals (according to type)



Ordering information

Example: 86 series multi-function timer module, (12...240)V AC/DC supply voltage.

8 6 . 0 0 . 0 . 2 4 0 . 0 0 0 0

Series

Type

0 = Multi-function (AI, DI, SW, BE, CE, DE, EE, FE)

3 = Bi-function (AI, DI)

No. of poles

See 40, 44, 46, 55, 56, 60 and 62 series relays

Poles for chosen relay/socket combination - according to chart below

Supply voltage

024 = (12...24)V AC/DC (86.30 only)

120 = (110...125)V AC (86.30 only)

240 = (12...240)V AC/DC (86.00 only)

240 = (12...48)V AC/DC

(86.00.0.240.0073 only)

240 = (230...240)V AC (86.30 only)

Supply version

0 = AC (50/60 Hz)/DC

8 = AC (50/60 Hz)

Combinations

Number of poles	Relay type	Socket type	Timer module
1	40.31	95.P3/95.03	86.30
1	40.61	95.P5/95.05	86.30
1	46.61	97.P1/97.01	86.30
2	40.52/44.52/44.62	95.P5/95.05	86.30
2	46.52	97.P2/97.02	86.30
2	55.32	94.P4/94.02	86.30
2	56.32	96.02	86.30
2	60.12	90.02	86.00/86.30
2	62.32	92.03	86.00/86.30
3	55.33	94.P3/94.03	86.30
3	60.13	90.03	86.00/86.30
3	62.33	92.03	86.00/86.30
4	55.34	94.P4/94.04	86.30
4	56.34	96.04	86.00/86.30

Other data Timer ATEX versions

Code available	Nominal tension	Operating range	Use temperature
86.00.0.240.0073	12-48 V AC/DC	10.2...60 V AC/DC	-20...+50°C
86.30.0.024.0073	12-24 V AC/DC	9.6...33.6 V AC/DC	-20...+50°C

Markings - ATEX versions - ATEX, II 3G Ex ec IIC Gc

MARKING	
	Specific marking of explosion protection
II	Component for surface plant (different from mines)
3	Category 3: normal level of protection
GAS	G Explosive atmosphere due to presence of combustible gas vapour or mist
	Ex ec Increased security
	IIC Gas group
	Gc Equipment Protection Level
-20 °C ≤ Ta ≤ +50 °C Ambient temperature	
EPTI 17 ATEX 0264 U EPTI: laboratory which issues the CE type certificate 17: year of issue of certificate 0264: number of CE type certificate	
U: ATEX component	

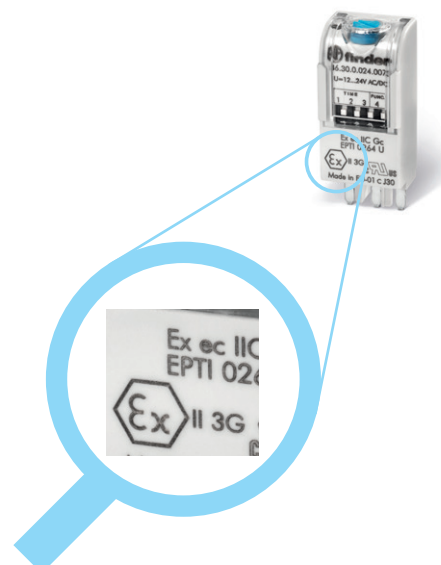

Technical data

EMC specifications				
Type of test		Reference standard	86.00	86.30
Electrostatic discharge	contact discharge	EN 61000-4-2	4 kV	n.a.
	air discharge	EN 61000-4-2	8 kV	8 kV
Radio-frequency electromagnetic field (80 ÷ 1000 MHz)		EN 61000-4-3	10 V/m	10 V/m
Fast transients (burst) (5-50 ns, 5 kHz) on Supply terminals		EN 61000-4-4	4 kV	2 kV
Surges (1.2/50 µs) on Supply terminals	common mode	EN 61000-4-5	4 kV	2 kV
	differential mode	EN 61000-4-5	4 kV	1 kV
Radio-frequency common mode (0.15 ÷ 80 MHz) on Supply terminals		EN 61000-4-6	10 V	10 V
Radiated and conducted emission		EN55022	class B	class B
Other data		86.00	86.30	
Current absorption on signal control (B1)		mA	1	—
Power lost to the environment	without contact current	W	0.1 (12 V) - 1 (230 V)	0.2
	with rated current		See 56, 60 and 62 series relays	See 40, 44, 46, 55, 56, 60, 62 series relays

Times scales

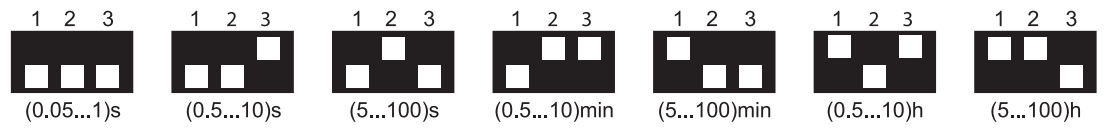

NOTE: Time scales and functions must be set before energising the timer.

To achieve the minimum time setting of 0.05 seconds it is necessary to use one of the functions with control signal. When setting very short times it may be necessary to take into account the operate time of the relay used.

Outline drawings

Type 86.00

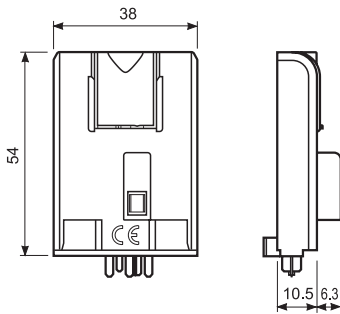

Type 86.30

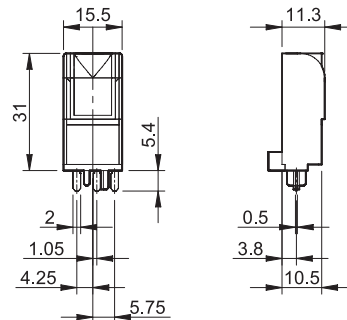

Functions

U = Supply voltage
S = Signal switch
— = Output contact

LED Type 86.00	LED Type 86.30	Supply voltage	NO output contact
		OFF	Open
		ON	Open
		ON	Open (Timing in Progress)
		ON	Closed

Without control signal = Start via contact in supply line (A1).
With control signal = Start via contact into control terminal (B1).

Wiring diagram

Without control signal

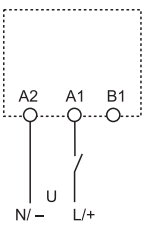

Type 86.00

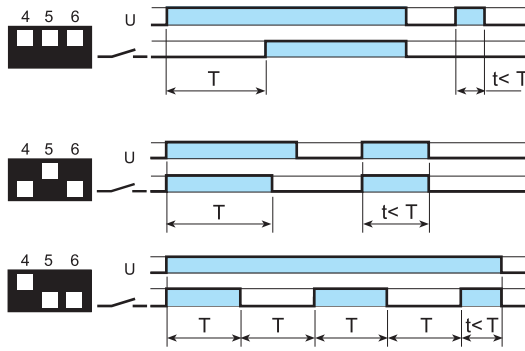

(AI) On-delay.
Apply power to timer. Output contacts transfer after preset time has elapsed. Reset occurs when power is removed.

(DI) Interval.
Apply power to timer. Output contacts transfer immediately. After the preset time has elapsed, contacts reset.

(SW) Symmetrical flasher (starting pulse on).
Apply power to timer. Output contacts transfer immediately and cycle between ON and OFF for as long as power is applied. The ratio is 1:1 (time on = time off).

With control signal

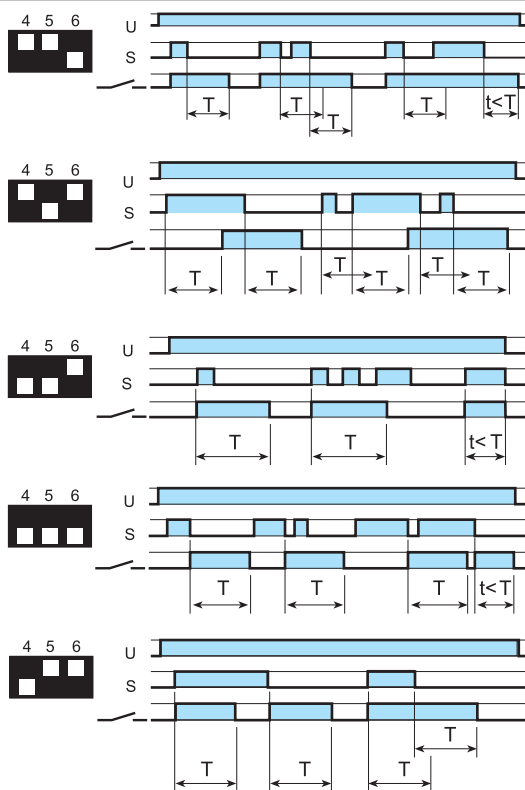
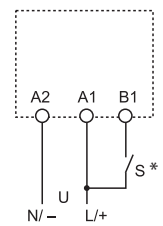

(BE) Off-delay with control signal.
Power is permanently applied to the timer. The output contacts transfer immediately on closure of the Signal Switch (S). Opening the Signal Switch initiates the preset delay, after which time the output contacts reset.

(CE) On- and off-delay with control signal.
Power is permanently applied to the timer. Closing the Signal Switch (S) initiates the preset delay, after which time the output contacts transfer. Opening the Signal switch initiates the same preset delay, after which time the output contacts reset.

(DE) Interval with control signal on.
Power is permanently applied to the timer. On momentary or maintained closure of Signal Switch (S), the output contacts transfer, and remain so for the duration of the preset delay, after which they reset.

(EE) Interval with control signal off.
Power is permanently applied to the timer. On opening of the Signal Switch (S) the output contacts transfer, and remain so for the duration of the preset delay, after which they reset.

(FE) Interval with control signal on and off.
Power is permanently applied to the timer. Both the opening and closing of the Signal Switch (S) initiates the transfer of the output contacts. In both instances the contacts reset after the delay period has elapsed.

* With DC supply, positive polarity has to be connected to B1 terminal (according to EN 60204-1). Switch S should be exclusively used to provide the control signal to terminal B1. (Do not connect any other load at this point).

Wiring diagram

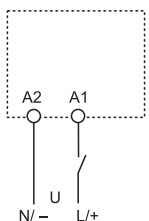

Type 86.30

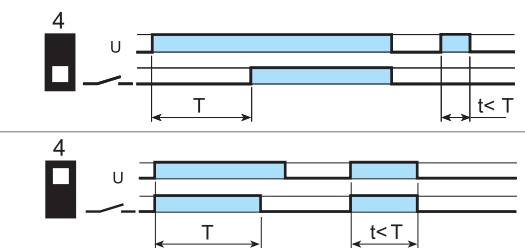

(AI) On-delay.
Apply power to timer. Output contacts transfer after preset time has elapsed. Reset occurs when power is removed.

(DI) Interval.
Apply power to timer. Output contacts transfer immediately. After the preset time has elapsed, contacts reset.



90.03
Approvals
(according to type):



Screw terminal (Box clamp) socket panel or 35 mm rail (EN 60715) mount	90.02 Blue	90.02.0 Black	90.03 Blue	90.03.0 Black
For relay type	60.12		60.13	
Accessories				
Metal retaining clip	090.33			
6-way jumper link	090.06			
Identification tag	090.00.2			
Timer module	86.00, 86.30			
Technical data				
Double terminal A1 (for easy start connection)				
Rated values	10 A - 250 V			
Dielectric strength	2 kV AC			
Protection category	IP 20			
Ambient temperature	°C -40...+70			
Screw torque	Nm 0.6			
Wire strip length	mm 10			
Max. wire size for 90.02 and 90.03 sockets	solid wire		stranded wire	
	mm ² 1 x 6 / 2 x 2.5		1 x 4 / 2 x 2.5	
	AWG 1 x 10 / 2 x 14		1 x 12 / 2 x 14	

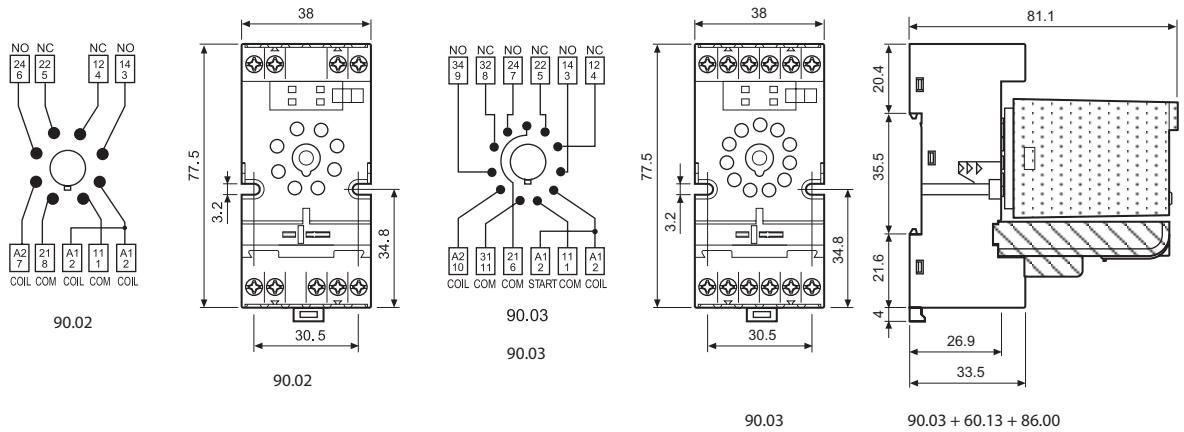

H

6-way jumper link for 90.02 and 90.03 sockets	090.06
Rated values	10 A - 250 V

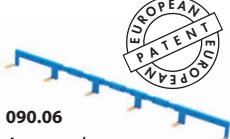

090.06
Approvals
(according to type):

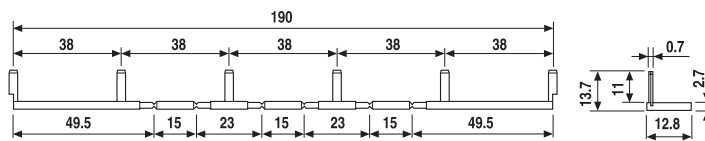



92.03
Approvals
(according to type):



Screw terminal (Box clamp) socket panel or 35 mm rail (EN 60715) mount	92.03 Blue	92.03.0 Black
For relay type	62.32, 62.33	
Accessories		
Metal retaining clip (supplied with socket - packaging code SMA)	092.71	
Identification tag	092.00.2	
Timer modules	86.00, 86.30	
Technical data		
Rated values	16 A - 250 V	
Dielectric strength	6 kV (1.2/50 μs) between coil and contacts	
Protection category	IP 20	
Ambient temperature	°C -40...+70 (see diagram L92)	
Screw torque	Nm	0.8
Wire strip length	mm 10	
Max. wire size for 92.03 socket	solid wire	stranded wire
	mm ²	1 x 10 / 2 x 4
	AWG	1 x 8 / 2 x 12

L 92 - Rated current v ambient temperature

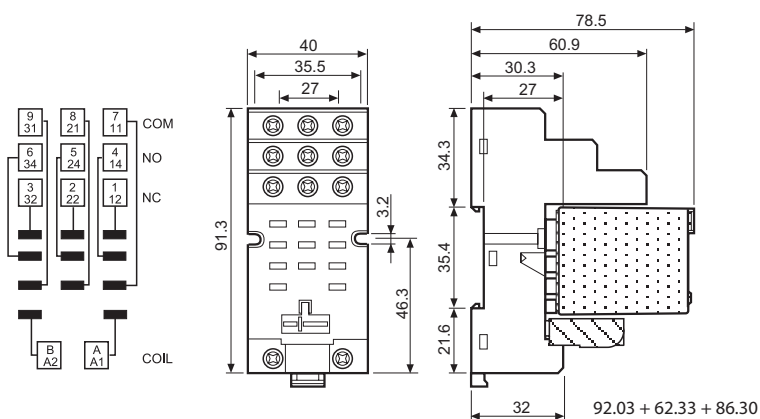
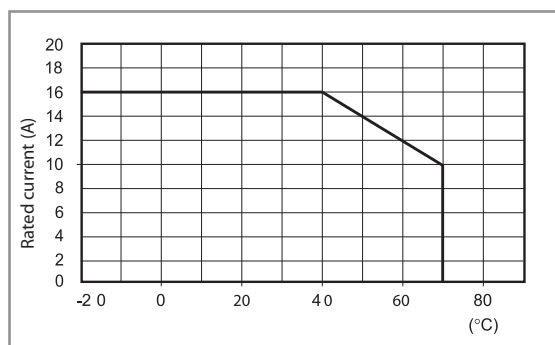

94.P4

Approvals
(according to type):



Certain relay/socket combinations



094.91.3

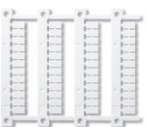

060.48

Push-in terminal socket panel or 35 mm (EN 60715) rail mount	94.P3 Blue	94.P4 Blue
For relay type	55.33	55.32, 55.34
Accessories		
Metal retaining clip		094.71
Plastic retaining and release clip (supplied with socket - packaging code SPA)		094.91.3
6-way jumper link		094.56
Identification tag		094.00.4
2-way jumper link		094.52.1
2-way jumper link		097.52
Marker tag holder		097.00
Timer modules (see table below)		86.30
Sheet of marker tags for plastic retaining and release clip 094.91.3 and for marker tag holder 097.00, 48 tags, 6 x 12 mm for CEMBRE thermal transfer printers		060.48
Technical data		
Rated values	10 A - 250 V	
Dielectric strength	2 kV AC	
Protection category	IP 20	
Ambient temperature	°C -40...+70	
Wire strip length	mm 8	
Min. wire size for 94.P3 and 94.P4 sockets	solid wire	stranded wire
	mm ² 0.5	0.5
Max. wire size for 94.P3 and 94.P4 sockets	AWG 21	21
	solid wire	stranded wire
mm ² 2 x 1.5 / 1 x 2.5	2 x 1.5 / 1 x 2.5	
AWG 2 x 18 / 1 x 14	2 x 18 / 1 x 14	

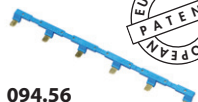
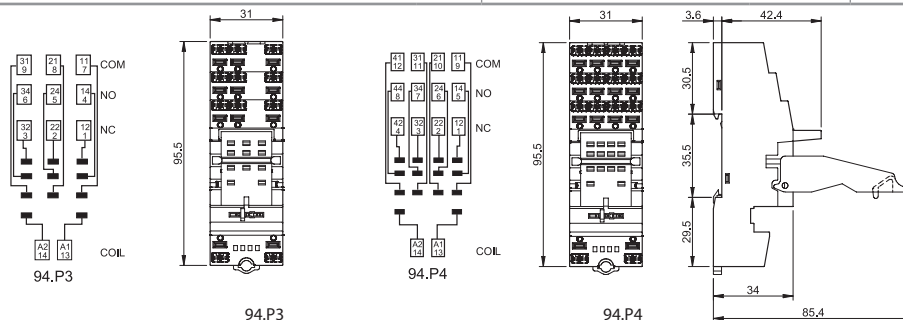

094.56



6-way jumper link for 94.P3 and 94.P4 sockets	094.56 (blue)
Rated values	10 A - 250 V

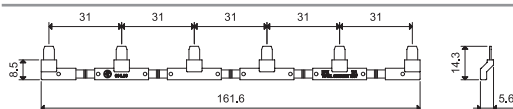

094.52.1

2-way jumper link for 94.P3 and 94.P4 sockets	094.52.1
Rated values	10 A - 250 V

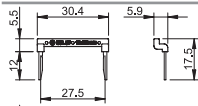

097.52

2-way jumper link for 94.P3 and 94.P4 sockets	097.52
Rated values	10 A - 250 V

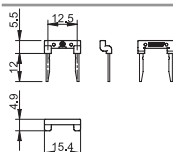

097.00

Marker tag holder for 94.P3 and 94.P4 sockets	097.00
--	--------

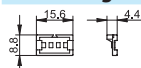

86.30

86 series timer modules	
(12...24)V AC/DC; Bi-function: AI, DI; (0.05 s...100 h)	86.30.0.024.0000
(110...125)V AC; Bi-function: AI, DI; (0.05 s...100 h)	86.30.8.120.0000
(230...240)V AC; Bi-function: AI, DI; (0.05 s...100 h)	86.30.8.240.0000

Approvals (according to type):



94.04

Approvals
(according to type):



cULus Certain relay/socket combinations



094.91.3

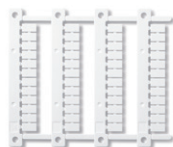

060.48

Screw terminal (Box clamp) socket panel or 35 mm (EN 60715) rail mount	94.02 Blue	94.02.0 Black	94.03 Blue	94.03.0 Black	94.04 Blue	94.04.0 Black
For relay type	55.32		55.33		55.32, 55.34	
Accessories						
Metal retaining clip	094.71					
Plastic retaining and release clip (supplied with socket - packaging code SPA)	094.91.3	094.91.30	094.91.3	094.91.30	094.91.3	094.91.30
6-way jumper link	094.06	094.06.0	094.06	094.06.0	094.06	094.06.0
Identification tag	094.00.4					
Marker tag holder	097.00					
Timer modules (see table below)	86.30					
Sheet of marker tags for plastic retaining and release clip 094.91.3 and for marker tag holder 097.00, 48 tags, 6 x 12 mm for CEMBRE thermal transfer printers	060.48					
Technical data						
Rated values	10 A - 250 V					
Dielectric strength	2 kV AC					
Protection category	IP 20					
Ambient temperature	°C -40...+70					
Screw torque	Nm 0.5					
Wire strip length	mm 8					
Max. wire size for 94.02/03/04 sockets	solid wire			stranded wire		
	mm ² 1 x 6 / 2 x 2.5			1 x 4 / 2 x 2.5		
	AWG 1 x 10 / 2 x 14			1 x 12 / 2 x 14		

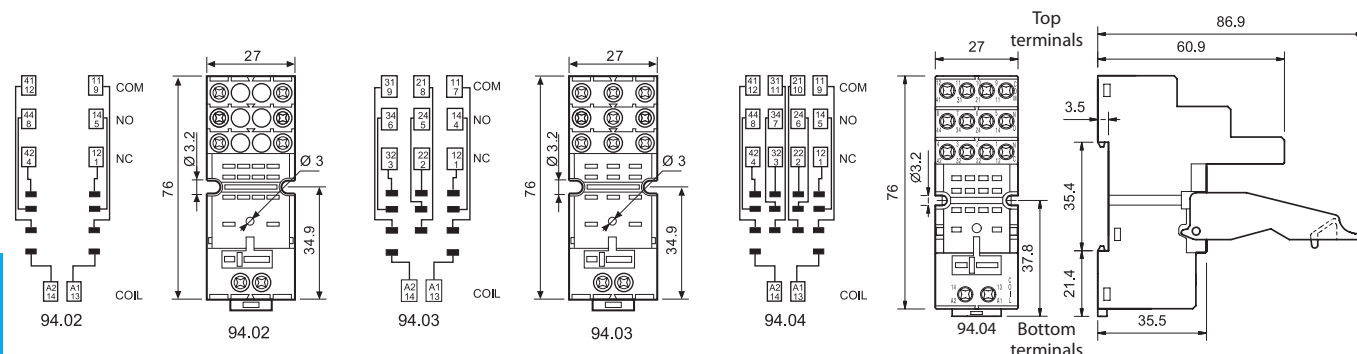

6-way jumper link for 94.02, 94.03 and 94.04 sockets	094.06 (blue)	094.06.0 (black)
Rated values	10 A - 250 V	



094.06

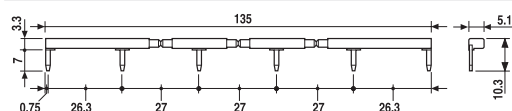

86.30

86 series timer modules	
(12...24)V AC/DC; Bi-function: AI, DI; (0.05 s...100 h)	86.30.0.024.0000
(110...125)V AC; Bi-function: AI, DI; (0.05 s...100 h)	86.30.8.120.0000
(230...240)V AC; Bi-function: AI, DI; (0.05 s...100 h)	86.30.8.240.0000

Approvals (according to type):

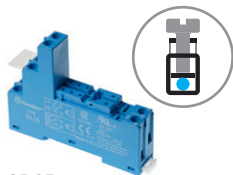

95.05
Approvals
(according to type):



UL US Certain relay/socket combinations



095.01

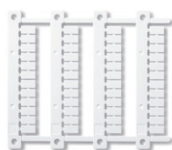

060.48

Screw terminal (Box clamp) socket panel or 35 mm rail mount	95.03 (blue)	95.03.0 (black)	95.05 (blue)	95.05.0 (black)
For relay type	40.31		40.51, 40.52, 40.61	
Accessories				
Metal retaining clip			095.71	
Plastic retaining and release clip (supplied with socket - packaging code SPA)	095.01	095.01.0	095.01	095.01.0
8-way jumper link	095.18	095.18.0	095.18	095.18.0
Marker tag holder (for tags 060.48 type)			097.00	
Identification tag			095.00.4	
Timer modules (see table below)			86.30	
Sheet of marker tags for plastic retaining and release clip 095.01 and for marker tag holder 097.00, 48 tags, 6 x 12 mm, for CEMBRE thermal transfer printers			060.48	
Technical data				
Rated values	10 A - 250 V*			
Dielectric strength	6 kV (1.2/50 μs) between coil and contacts			
Protection category	IP 20			
Ambient temperature	°C -40...+70 (see diagram L95)			
Screw torque	Nm	0.5		
Wire strip length	mm	8		
Max. wire size for 95.03 and 95.05 sockets		solid wire	stranded wire	
	mm ²	1 x 6 / 2 x 2.5		1 x 4 / 2 x 2.5
	AWG	1 x 10 / 2 x 14		1 x 12 / 2 x 14

* For currents > 10 A, contact terminals must be connected in parallel (21 with 11, 24 with 14, 22 with 12).

L 95 - Total socket current v ambient temperature

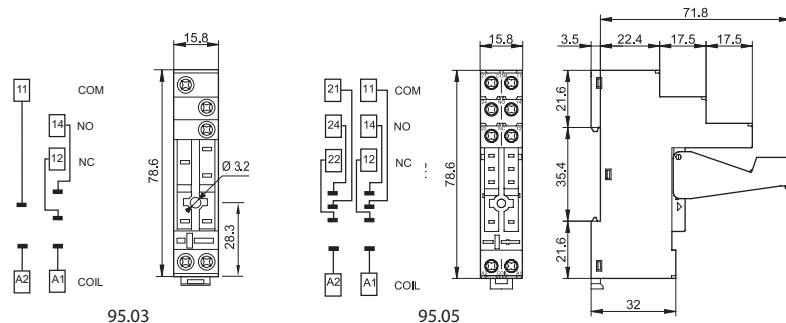
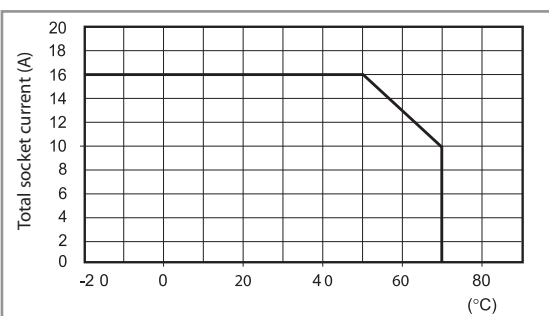

H

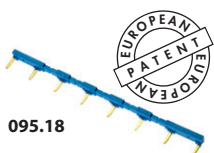

095.18



8-way jumper link for 95.03 and 95.05 sockets	095.18 (blue)	095.18.0 (black)
Rated values	10 A - 250 V	

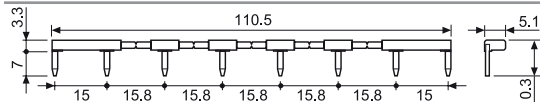

86 series timer modules	
(12...24)V AC/DC; Bi-function: AI, DI; (0.05 s...100 h)	86.30.0.024.0000
(110...125)V AC; Bi-function: AI, DI; (0.05 s...100 h)	86.30.8.120.0000
(230...240)V AC; Bi-function: AI, DI; (0.05 s...100 h)	86.30.8.240.0000



86.30

Approvals (according to type):



96.02
Approvals
(according to type):

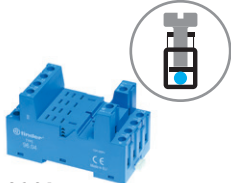

96.04
Approvals
(according to type):



094.91.3

Screw terminal (Box clamp) socket panel or 35 mm rail (EN 60715) mount	96.02 Blue	96.02.0 Black	96.04 Blue	96.04.0 Black
For relay type	56.32		56.34	
Accessories				
Metal retaining clip (supplied with socket - packaging code SMA)	094.71		096.71	
Plastic retaining and release clip (supplied with socket - packaging code SPA)	094.91.3	094.91.30	—	—
6-way jumper link	094.06	094.06.0	—	—
Identification tag	095.00.4		090.00.2	
Timer modules	86.30		86.00, 86.30	
Technical data				
Rated values	12 A - 250 V			
Dielectric strength	2 kV AC			
Protection category	IP 20			
Ambient temperature	°C -40...+70			
Screw torque	Nm	0.8		
Wire strip length	mm	8		
Max. wire size for 96.02/04 sockets		solid wire	stranded wire	
	mm ²	1 x 6 / 2 x 2.5	1 x 4 / 2 x 2.5	
	AWG	1 x 10 / 2 x 14	1 x 12 / 2 x 14	

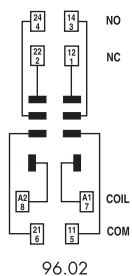

96.02

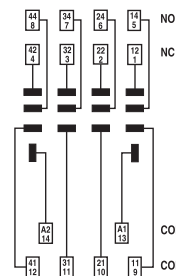

96.04

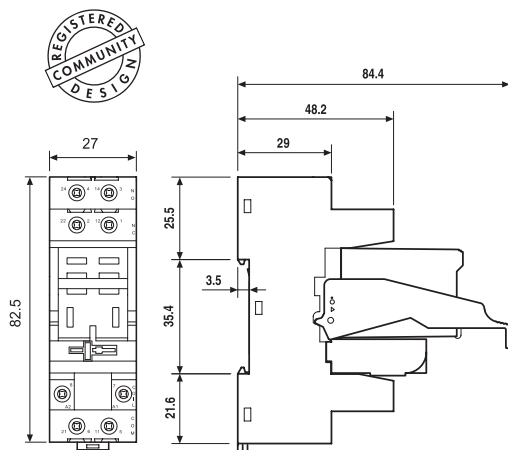

96.02

96.02 + 56.32 + 094.91.3 + 86.30

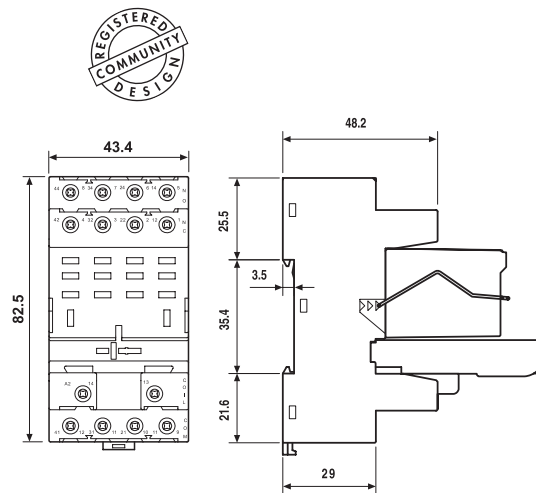

96.04

96.04 + 56.34 + 096.71 + 86.00



094.06



6-way jumper link for 96.02 socket	094.06 (blue)	094.06.0 (black)
Rated values	10 A - 250 V	

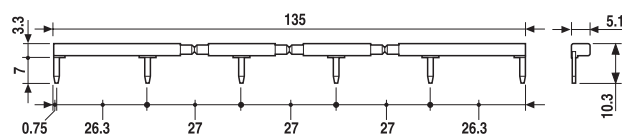



97.P2

Approvals
(according to type):



097.01

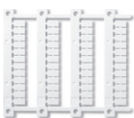

060.48

Push-in terminal socket panel or 35 mm rail (EN 60715) mount	97.P1	97.P2
For relay type	46.61	46.52
Accessories		
Plastic retaining and release clip (supplied with socket - packaging code SPA)		097.01
Metal retaining clip		097.71
Identification tag		095.00.4
8-way jumper link		097.58
2-way jumper link		097.52
2-way jumper link		097.42
Marker tag holder		097.00
Timer modules (see table below)		86.30
Sheet of marker tags for marker tag holder 097.00, 48 tags, 6 x 12 mm, for CEMBRE thermal transfer printers		060.48
Technical data		
Rated values	16 A-250 V AC	8 A-250 V AC
Dielectric strength	6 kV (1.2/50 μs) between coil and contacts	
Protection category	IP 20	
Ambient temperature	°C -40...+70 (see diagram L97)	
Wire strip length	mm 8	
Min. wire size for 97.P1 and 97.P2 socket	solid wire	stranded wire
	mm ² 0.5	0.5
	AWG 21	21
Max. wire size for 97.P1 and 97.P2 socket	solid wire	stranded wire
	mm ² 2 x 1.5 / 1 x 2.5	2 x 1.5 / 1 x 2.5
	AWG 2 x 18 / 1 x 14	2 x 18 / 1 x 14

L 97 - Rated current v ambient temperature

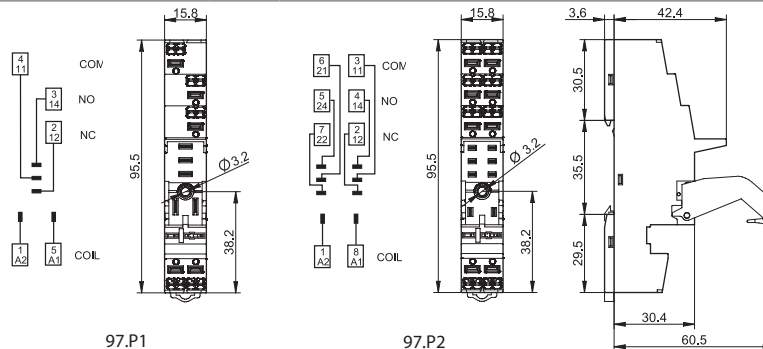
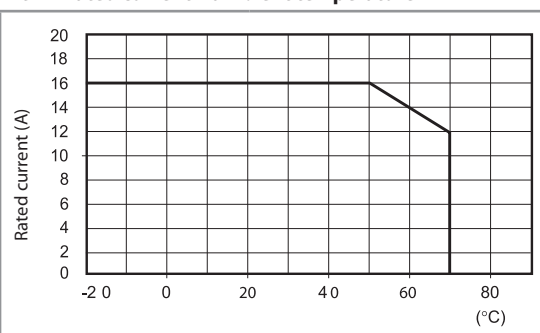

8-way jumper link for 97.P1 and 97.P2 sockets	097.58
Rated values	10 A - 250 V

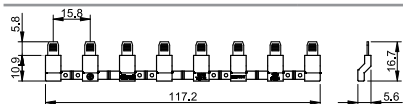

097.58

2-way jumper link for 97.P1 and 97.P2 sockets	097.52
Rated values	10 A - 250 V

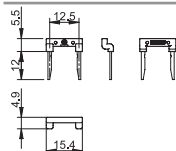

097.52

2-way jumper link for 97.P1 and 97.P2 sockets	097.42
Rated values	10 A - 250 V

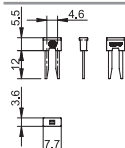

097.42

Marker tag holder for 95.P3 and 95.P5 sockets	097.00
--	--------

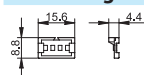

097.00

86 series timer modules	
(12...24)V AC/DC; Bi-function: AI, DI; (0.05 s...100 h)	86.30.0.024.0000
(110...125)V AC; Bi-function: AI, DI; (0.05 s...100 h)	86.30.8.120.0000
(230...240)V AC; Bi-function: AI, DI; (0.05 s...100 h)	86.30.8.240.0000

Approvals (according to type):



86.30

H

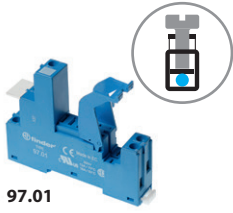

97.01
Approvals
(according to type):



097.01

Screw terminal socket	97.01	97.02
panel or 35 mm rail (EN 60715) mount	Blue	Blue
For relay type	46.61	46.52
Accessories		
Plastic retain and eject clip (supplied with socket - packaging code SPA)	097.01	
8-way jumper link	095.18 (blue)	095.18.0 (black)
Identification tag	095.00.4	
Timer modules	86.30	
Technical data		
Rated current	16 A - 250 V AC	8 A - 250 V AC
Dielectric strength	6 kV (1.2/50 μs) between coil and contacts	
Protection category	IP 20	
Ambient temperature	°C -40...+70 (see diagram L97)	
Screw torque	Nm	0.8
Wire strip length	mm	8
Max. wire size for 97.01 and 97.02 sockets	solid wire	stranded wire
	mm ²	1 x 6 / 2 x 2.5
	AWG	1 x 10 / 2 x 14

L 97 - Rated current v ambient temperature
(for 46.61 relay / 97.01 socket combination)

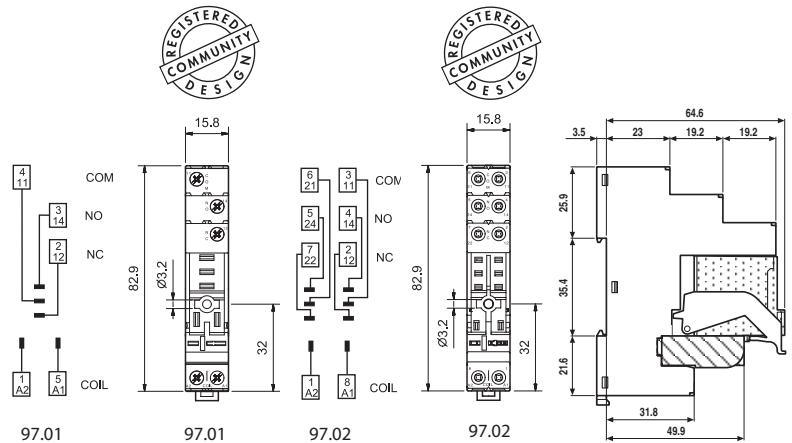
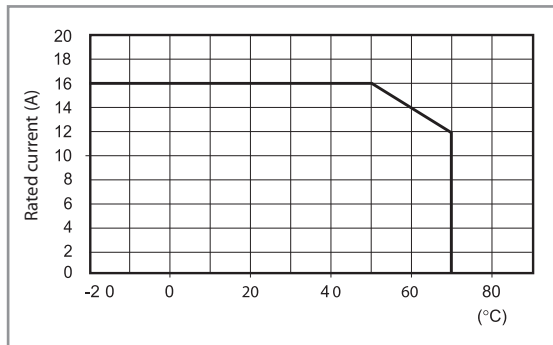

97.02 + 46.52 + 097.01
+ 86.30



095.18



8-way jumper link for 97.01 and 97.02 sockets	095.18 (blue)	095.18.0 (black)
Rated values	10 A - 250 V	

